

Operating Instructions

MLA 900 Conductivity meter for light petroleum products



Operation
Maintenance
Approvals



Document information

Document ID

Title: Operating Instructions MLA 900
Order No.: 8011381
Version: 2.1
Status: 2010-10

Subject

Product name: MLA 900
Software: Version 1.1

Manufacturer

MBA Instruments GmbH
Friedrich-List-Str. 7 · D-25451 Quickborn · Germany
Phone: +49 (0) 41 06 123 888-0
Fax: +49 (0) 41 06 123 888-9
E-Mail: info@mba-instruments.de

Trademarks

IBM is a trademark of the International Business Machine Corporation.
MS-DOS and Windows are trademarks of the Microsoft Corporation.
Other product names used in this document may also be trademarks and are only used for identification purpose.

© MBA Instruments GmbH. All rights reserved.

Warning symbols



Hazard (general)



Hazard in explosion-hazardous locations



Hazard by explosive substances/mixtures

Warning levels / signal words

WARNING

Risk or hazardous situation which could result in serious injury or death.

CAUTION

Hazard or unsafe practice which may result in minor or moderate personal injury.

NOTICE

Hazard or unsafe practice which could result in property damage.

Information symbols



Important technical information for this product



Nice to know



Supplementary information



Link to information at another place

1	For your own safety ...	5
1.1	General safety in hazardous locations	6
1.2	Essential safety notes for the MLA 900	6
2	Notes on application	7
2.1	Approved use	8
2.1.1	Designated use	8
2.1.2	Application restrictions	8
2.1.3	Regulations and standards fulfilled	9
2.2	Official approval	9
2.2.1	Definitions of terms	9
2.2.2	Approval for the MLA 900	10
3	Preparing for operation	11
3.1	Supply schedule	12
3.2	Assembly	13
4	Handling	15
4.1	Display unit	17
4.1.1	Handling	17
4.1.2	Switching on and off	17
4.1.3	Measuring value displays	17
4.2	Fault/limit value displays	19
4.3	Performance test	21
4.4	Measuring procedure	23
4.5	Measures in the event of a fault/damage	24
5	Maintenance	25
5.1	Cleaning	27
5.1.1	Cleaning the probe cable	27
5.1.2	Cleaning the measuring probe	27
5.1.3	Cleaning the display unit	27
5.2	Battery	29
5.3	Spare parts	30
6	Storage, transport	31
6.1	Correct storage	32
6.2	Short-distance transports	32
6.3	Correct shipping	32
6.4	Shipping for repair	33
7	Approval certificate	35

MLA 900

1 For your own safety ...

General safety
Essential safety notes

1.1 General safety in hazardous locations

**WARNING:**

- ▶ *Before using the instrument for the first time in a hazardous location:* Observe all the safety instructions in these operating instructions.

1.2

Essential safety notes for the MLA 900

- ▶ Observe the following safety notes when assembling and operating the instrument, during maintenance and repair, and when exchanging parts – for your own protection.

The most important safety rules are:

**CAUTION: Risk of wrong measurements**

- ▶ *Before using the MLA 900:* carry out a performance test (→ S. 21, §4.3) – always to be done outside of the hazardous locations.

**WARNING: Hazard when potential equalisation is missing:**

- ▶ *Before the measuring probe is lowered into the liquid container:* Safely connect the ground clamp of the display unit with the liquid container (potential equalisation).

**WARNING: Hazard when enclosure is open**

- ▶ Never open the instrument enclosure as long as it is in a hazardous location.

**WARNING: Hazard by unsafe instrument**

- ▶ *If there is any reason to assume that the instrument is no longer safe:* shut down the instrument and protected it against unauthorised use.

MLA 900

2 Notes on application

Designated use
Application restrictions
Official approval

2.1 Approved use

2.1.1 Designated use

Measuring function

The MLA 900 determines the electrical conductivity and the temperature of petroleum products such as occur, for example, in aviation fuels and in other petroleum products.

During the filling process, pumping or filtering, these liquids may become electrostatically charged. If, in addition, there is an inflammable gas mixture present in the ambient atmosphere, there is a danger that the gas mixture will be ignited by a discharge spark, which means that it may explode. To evaluate this risk, the electrical conductivity of the liquid is measured (see German standard DIN 51 412-T02-79, »Determining electrical conductivity, field procedure«).

The conductivity is stated in the physical unit »pS/m« (picosiemens per meter). This unit corresponds to »c.u.« (conductivity unit), which is still commonly used in the petroleum industry:

$$1 \frac{\text{pS}}{\text{m}} = 1 \text{ c.u.}$$

Ambient conditions

The MLA 900 is designed as a measuring instrument for outside use.

- ▶ Use the MLA 900 at an ambient temperature of $-20\text{ °C} \dots +60\text{ °C}$ ($-4 \dots +140\text{ °F}$).

Outside this temperature range it can no longer be guaranteed that the instrument will function correctly.



- At temperatures above $+60\text{ °C}$ (140 °F) there is a danger that caustic liquid from the battery may escape and damage the electronics. Apart from this, the LC displays may be damaged (irreversible blackening).
- At temperatures of below -20 °C (-4 °F), the LC displays in the display unit may freeze, resulting in the LC display enclosure bursting.
- Low temperatures affect the flexibility of the probe cable.
 - ▶ Avoid bending the probe cables in low temperatures.
 Otherwise the probe cable could brake due to the sheath becoming brittle.

2.1.2 Application restrictions

The MLA 900 may only be used to measure the conductivity and temperature of petroleum products, such as petrol, kerosene and oils/greases. Other liquids such as acids or solvents containing chlorinated hydrocarbons, for example, can damage the measuring probe.

component	clean with	avoid contact with
measuring probe probe cables	petrol spirit (ethanol) isopropanol	acids chlorinated hydrocarbons (CHC) methanol acetone

2.1.3 Regulations and standards fulfilled

The MLA 900 measuring procedure corresponds to:

- German standard DIN 51 412-T02-79 (»Determining electrical conductivity, field procedure«)
- ASTM 02624 »Standard Test Methods for Electrical Conductivity of Aviation and Distillate Fuels«

The technical design of the MLA 900 corresponds to:

- European standard EN 60079-0:2006
- European standard EN 60079-11:2007
- European standard EN 60079-26:2007
- European Council Directive 94/9/EC (ATEX guideline)
- German »Ordinance on electrical appliances in hazardous locations« (»Verordnung über elektrische Anlagen in explosionsgefährdeten Räumen«, ElexV) of 13 December 1996.

2.2 Official approval

2.2.1 Definitions of terms

- An *explosive mixture* is a mixture of gases, vapours, mists or dusts in which a reaction continues independently after ignition.
- An *explosive atmosphere* contains explosive mixtures of gases, vapours, mists or dusts with air, including usual admixtures (for example, humidity) under atmospheric conditions. Atmospheric conditions are here defined as total pressures of 0.8 to 1.1 bar and gas mixture temperatures of from –20 °C to +60 °C.
A dangerous explosive atmosphere occurs when in the event of an ignition injury may be caused to persons as a direct or indirect result of the explosion.
- *Hazardous locations* are those areas in which a dangerous explosive atmosphere may occur due to local and operational conditions.
Hazardous locations are divided into zones on the basis the probability (in terms of time and place) of the presence of dangerous explosive atmospheres:
 - Zone 0 includes areas in which a dangerous explosive atmosphere is present »constantly or for longer periods«; for example, in tank facilities.
 - Zone 1 covers areas in which a dangerous explosive atmosphere »occasionally« occurs; for example, in the vicinity of refuelling nozzles.

2.2.2

Approval for the MLA 900**Approved area of application**

The MLA 900 is approved for use in hazardous locations in which inflammable gases, vapours or mists may occur (EEx ia IIB T6). The MLA 900 measuring probe is approved for use in Zone 0, the display unit for use in Zone 1.

Prescribed operating conditions

The following applies for the use of the MLA 900 conductivity meter in the area of application as defined in the »Ordinance on electrical appliances in hazardous locations (ElexV)«:

**WARNING: Hazards in explosions-hazardous locations**

- The MLA 900 is intended exclusively for mobile use at different locations.
- The measuring probe of the MLA 900 is approved for use in containers for inflammable liquids (Hazardous Location Zone 0).
- The display unit of the MLA 900 may only be used in Hazardous Location Zone 1.
- The measuring probe may only be used in such liquids against which the materials of which it is made offer adequate chemical resistance (→ S. 8, §2.1.2).
- Damaged measuring probes may not be used in Zone 0.
- Before the measuring probe is taken to Zone 0, all plug and threaded cable connections must be checked.
- The measuring probe may only be used with the appropriate display unit.
- Before the measuring probe is lowered into the liquid container (tank), the ground clamp of the display unit must be connected to the container to equalize the electric potentials.



Approval document → S. 36

MLA 900

3 Preparing for operation

Supplied parts
Assembly

3.1

Supply schedule

When delivered, the MLA 900 consists of:

- display unit with ground clamp
- measuring probe
- probe cable
 - standard length: 2 m
 - options: 10 m, 17 m
- transport case

**CAUTION: Risk of damage**

- Tight bending may damage the cable (cable breaks).
- Damaged cables must not be used in hazardous locations.
- ▶ Never buckle the probe cable and do not bend the cables too far.
- ▶ At temperatures below 0 °C (32 °F), treat the probe cable with particular care – because the cable sheath may become brittle at these temperatures. Avoid tight bending (risk of breakage).

Bild 1

MLA 900 supply schedule

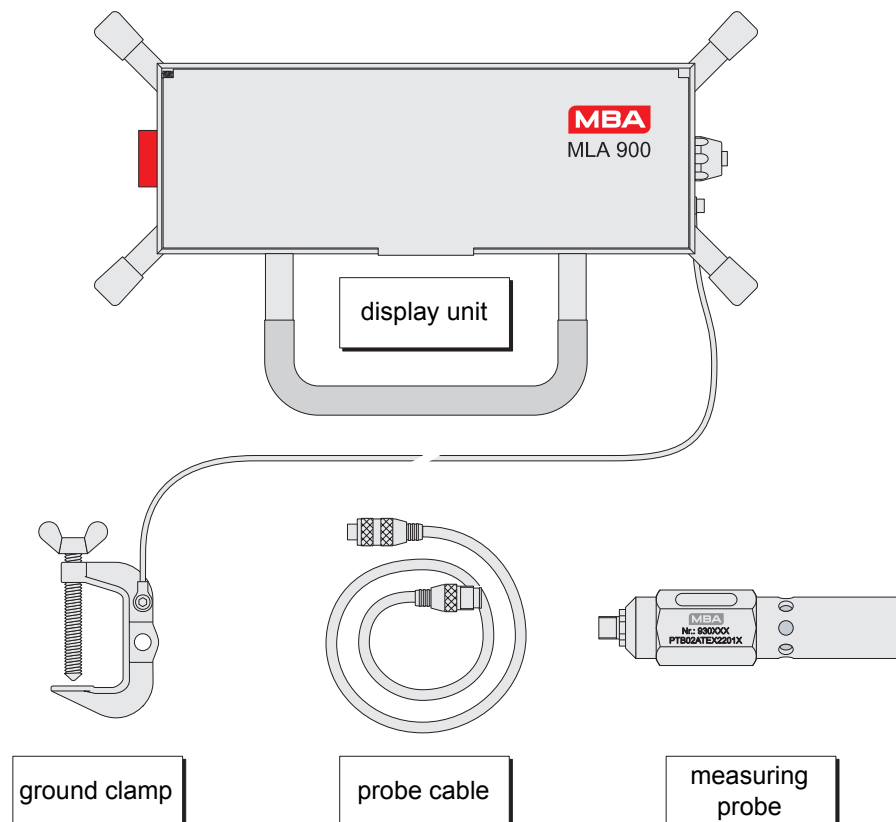

- Keep the transport box even if you do not wish to use it when operating the MLA 900. It may be useful as a shipping packaging.
- List of spare parts → S. 30, § 5.3

3.2

Assembly

The MLA 900 consists of four instrument components (measuring probe, display unit, ground clamp, probe cables). – Note: These components will only conform to the technical safety regulations for the petroleum industry when used as an assembled unit.

Measuring probe and display unit are a matching pair

Display unit and measuring probe have been individually adapted in the factory. If a different probe is connected, the measuring accuracy cannot be guaranteed.

- ▶ Only connect a measuring probe to a display unit with the identical serial number on it.

Probe cables

- ▶ Connect the display unit to the measuring probe with one of the probe cables supplied. (Choose the cable length which is the best for the application.)



You can also connect the probe cables to each other to have a 12 m length of cable. Greater cable lengths can be obtained by using further cable sections (order designations → S. 30, §5.3).

The maximum allowable total cable length is 24 m.



WARNING: Risk by wrong equipment

- ▶ Use only use cables of the type supplied to connect the display unit and the measuring probe.

It is not permitted to operate the instrument with other cables in hazardous locations.

Ground clamp

- ▶ Make sure that the ground clamp is firmly attached to the display unit (threaded connections, cable lugs).
- ▶ Do not start up the MLA 900 if this is not sure.

Bild 2

Connecting the probe cable

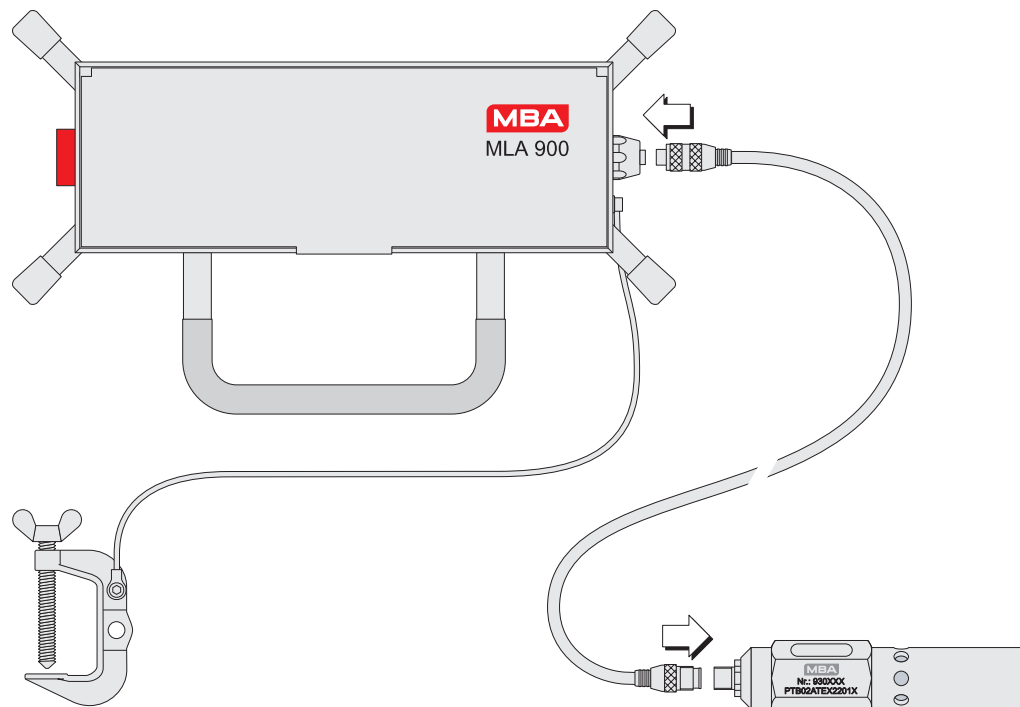

MLA 900

4 Handling

Instrument display
Performance test
Measuring procedure

Bild 3 Display unit

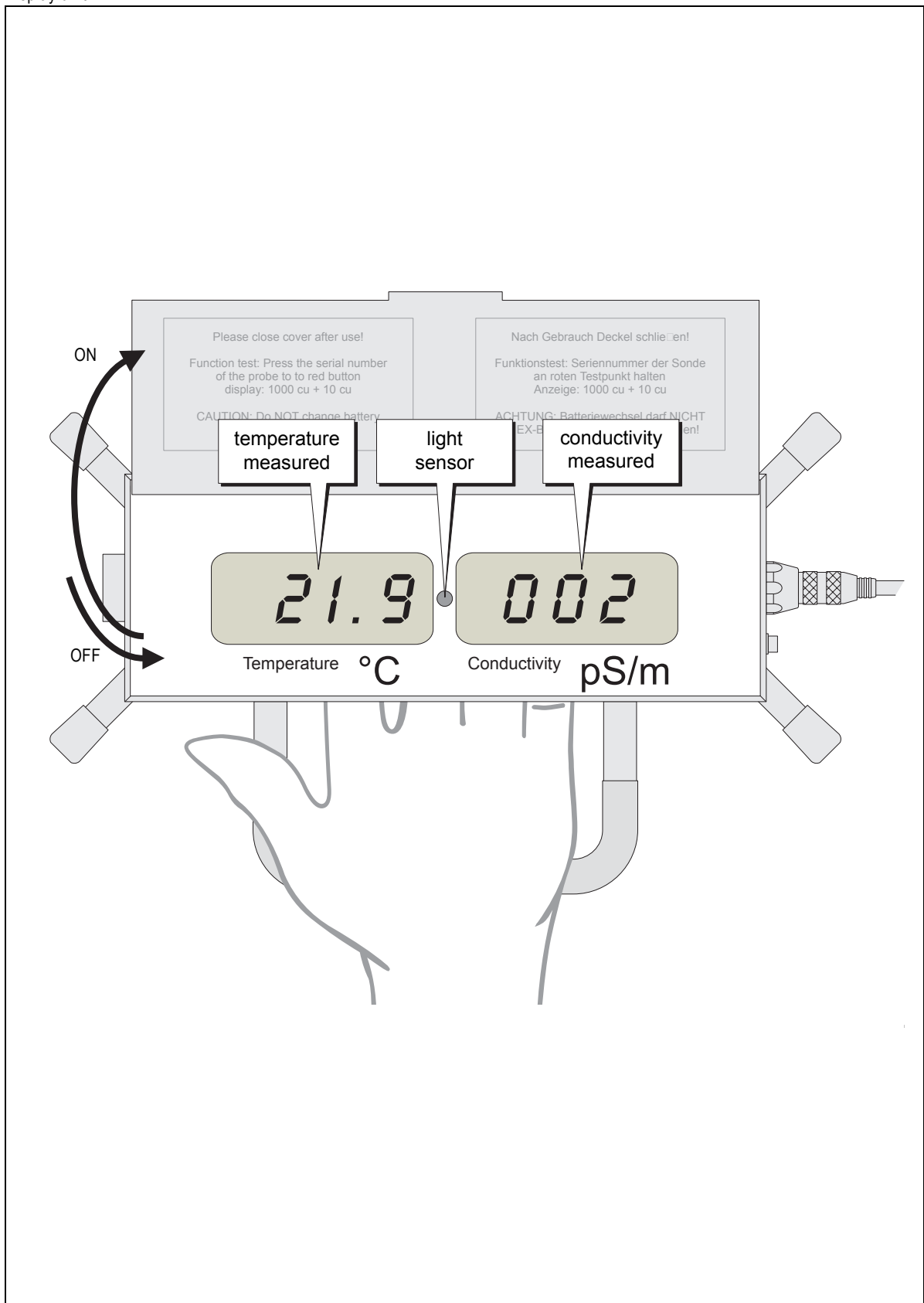

4.1 Display unit

4.1.1 Handling

Handling during transport

- ▶ Always use the carrying handle to carry the instrument.
- ⊗ Do not use the cover flap or the cable brackets to carry the instrument.

Handling during measurement

- ▶ During measurements, hold the display unit safely in your hand.



If you put the display unit down while measuring: make sure that it is standing securely – because it might be pulled down by the weight of the measuring probe, or even fall into the liquid container.



WARNING: Risks by wrong use

- ▶ In hazardous locations the display unit may only be operated within »Zone 1«.
- ▶ *Before the measuring probe is introduced into the liquid container (tank):* connect the ground clamp of the display unit to the container.

4.1.2 Switching on and off

- ▶ *Switching on:* Open the cover flap of the display unit.
 - The MLA 900 automatically starts up when the light sensor is exposed to light.
- ▶ *Switching off:* Close the cover flap.
 - When the flap is closed, the MLA 900 automatically shuts off.

4.1.3 Measuring value displays

left-hand display:
temperature of the measuring probe/ the liquid
Display range: $-199^{\circ}\text{C} \dots +199^{\circ}\text{C}$

right-hand display:
conductivity measured
Measuring range: $0 \dots 1999 \text{ pS/m}$

- ▶ Watch out for fault and limit value indications (→ S. 19, §4.2).



The MLA 900 is approved for measurement in hazardous locations only in a temperature range of $-20^{\circ}\text{C} \dots +60^{\circ}\text{C}$. This is the temperature range where the MLA 900 fulfils the stated specifications.

Bild 4 Fault/limit value displays

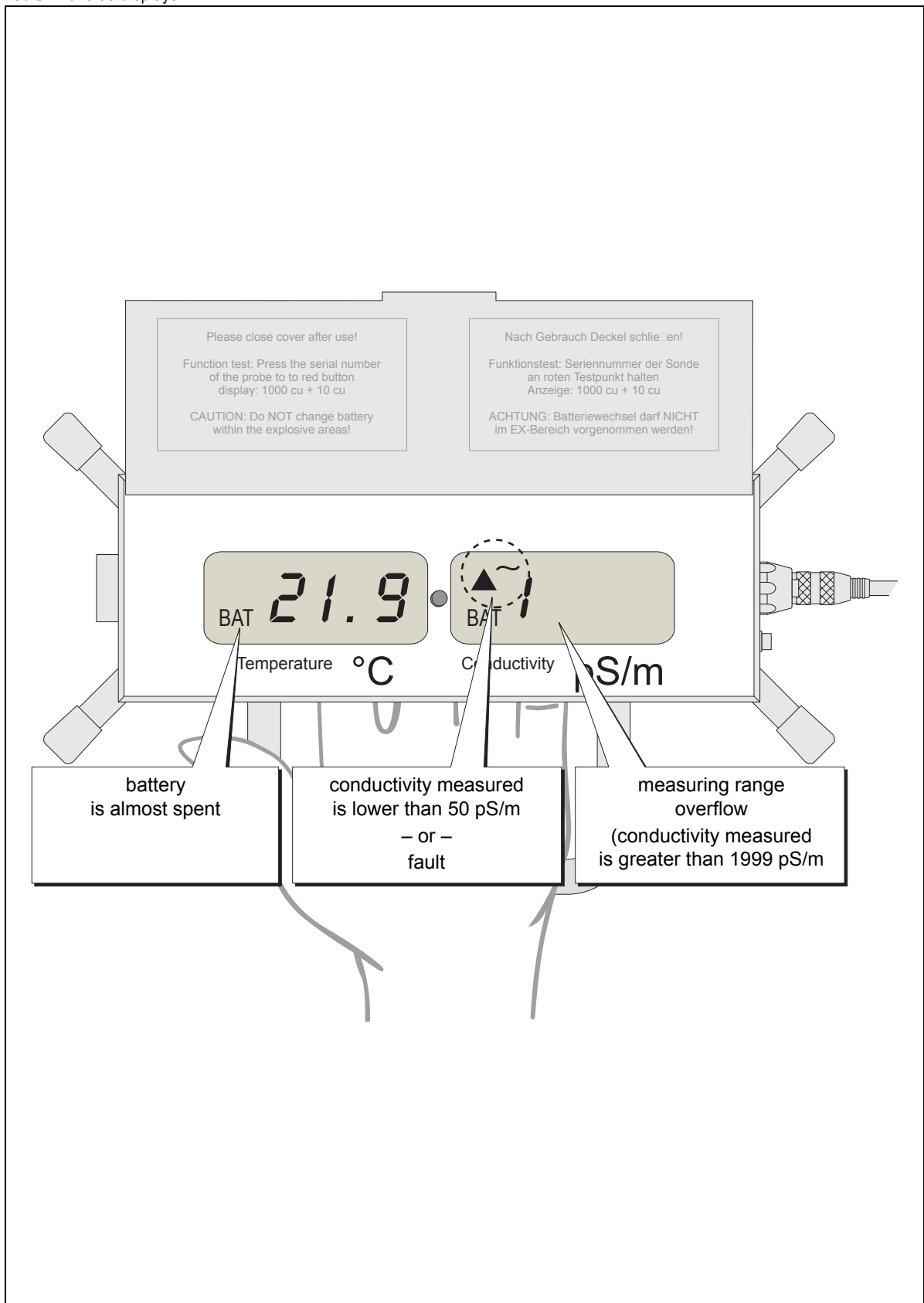

4.2

Fault/limit value displays*BAT* (shown on both displays)

Meaning	Measures/instructions
The life of the built-in battery is almost over. The battery voltage is lower than 8 V (new battery: 9 V).	▶ Replace the battery (→ S. 29, §5.2).

▲~

Meaning	Measures/instructions
The measuring probe is outside the liquid.	▶ Immerse the measuring probe in the liquid.
The conductivity of the sample solution is lower than $50 \mu\text{S/m}$.	▶ Observe the safety rules and carry out the measures laid down for this case.

▲~ $\bar{7}XXX$ + constantly changing temperature measuring value

Meaning	Measures/instructions
The probe cable is broken.	▶ Carry out a performance test (→ S. 21, §4.3). ▶ <i>If unsuccessful:</i> change the probe cable. Then carry out another performance test.
Measuring probe is badly contaminated or moist (splashed with water).	▶ Clean and dry the measuring probe (→ S. 27, §5.1).

**WARNING: Risk by damaged cable**

- ▶ Do not operate the instrument in hazardous locations if the probe cable is damaged or defective.
- ▶ Only change the probe cable outside hazardous locations.

7

Meaning	Measures/instructions
Measuring value is greater than $1999 \mu\text{S/m}$.	▶ Check whether the conductivity of the liquid can actually be greater than $1999 \mu\text{S/m}$.
Measuring probe is badly contaminated or moist (splashed with water).	▶ Clean and dry the measuring probe (→ S. 27, §5.1).
MLA 900 is damaged.	▶ Carry out a performance test (→ S. 21, §4.3).

Bild 5 Performance test

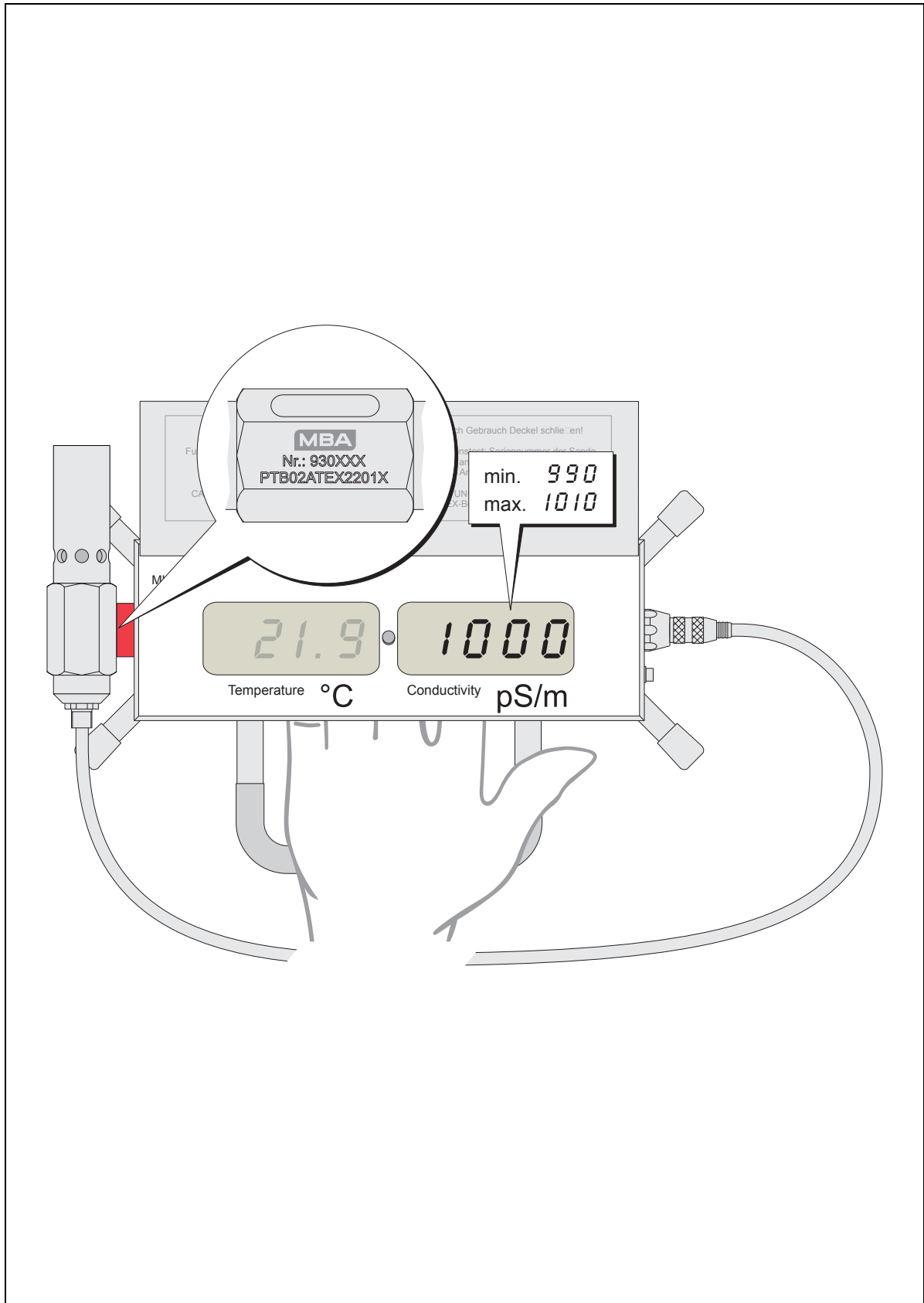

Performance test



CAUTION: Risk of wrong measurements

- ▶ Always make a performance test before operating the MLA 900.
- ▶ Perform this performance test outside hazardous locations.

Check condition of instrument

- 1 Make sure that
 - the cylinder of the measuring probe is tightly screwed on
 - the measuring probe is sufficiently clean and dry
 - display unit and measuring probe are correctly connected to each other (inspect cables and plug connectors).

Check basic condition

- 2 Open the cover flap of the display unit in order to switch on the MLA 900. Let the measuring probe hang free in the air.
 - The conductivity value measured should then read $-2 \dots 2 \text{ pS/m}$.
 - ▶ *If a value above 2 pS/m is displayed:* carefully clean the measuring probe (→ S. 27, §5.1).
 - ▶ *If a value below -2 pS/m is displayed:* check the battery (→ S. 29, §5.2).

Check measuring function

- 3 Hold the surface of the measuring probe with the company logo close to the red disc on the display unit.
 - The MLA 900 should display 1000 pS/m ($\pm 10 \text{ pS/m}$).
 - ▶ *If the value is not between 990 and 1010 pS/m :* check the battery (→ S. 29, §5.2).



A re-calibration (a new adaptation of measuring probe and electronics) is usually not required. If it is however necessary, this work must be made at the manufacturer's factory, for safety reasons. Please observe the transport instructions before shipping the instrument (→ S. 31, §6).

Bild 6 Measuring procedure

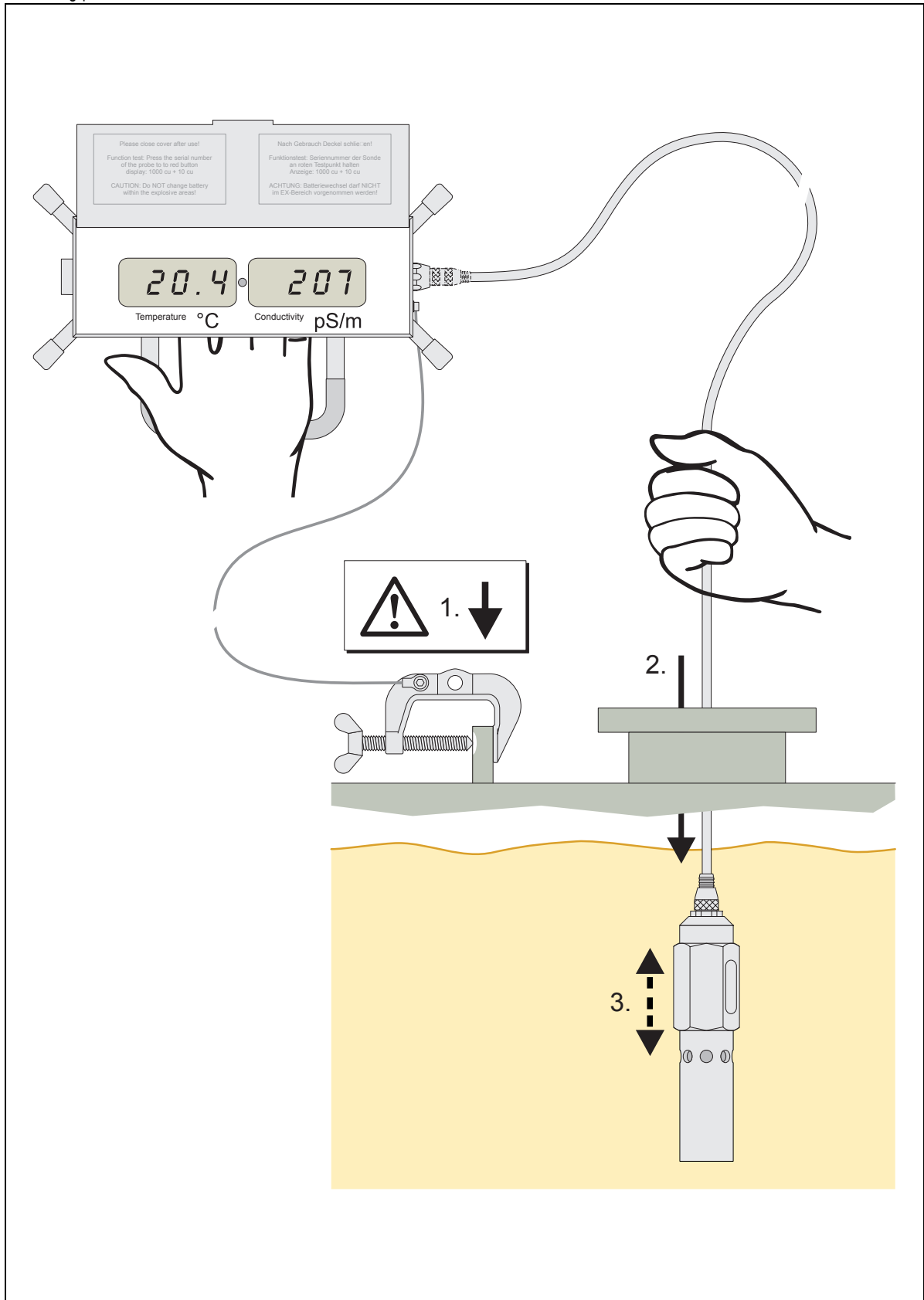

4.4

Measuring procedure**Checking the instrument**

1.	Measuring probe safely connected to the probe cable?	So that the measuring probe won't get lost in the liquid container.
2.	Cylinder of the measuring probe tightly screwed on	Otherwise wrong measurements and/or faults could occur (→ S. 19, §4.2).
3.	Measuring probe sufficiently clean?	Contamination results in wrong measuring results (cleaning → S. 27, §5.1).
4.	Connection of ground clamp and display unit in perfect condition?	Otherwise safety is not guaranteed.

Measuring

Hold the display unit in your hand or use the transport case for holding the display unit (do not put the display instrument down!).

- 1 *Connect the ground clamp:* Attach the ground clamp to a metallic, unpainted, rust-free and grease-free point on the liquid container. Make sure that there is a good metallic connection between the liquid container and the display unit.

**WARNING: Explosion risk**

- ▶ Do not lower the measuring probe into the liquid container before the ground clamp is safely connected to the container.

- 2 *Immerse the measuring probe:* Take the measuring probe and the probe cables out of the bracket on the display unit and lower the measuring probe, hanging from the cable, carefully into the liquid.
- 3 *Measure:* Open the cover flap of the display unit and read the measuring values. Note:



- ▶ Make sure that the measuring probe is completely filled with liquid. Air bubbles would distort the measuring result.
- ▶ If possible, measure the conductivity just when the desired immersion depth is reached, or move the measuring probe constantly while measuring.¹
- ▶ Wait for the final temperature reading until the temperature display remains approximately constant.²
- ▶ Please consider: there can be different temperatures at different depths.

¹ If the measuring probe is resting in the liquid, the conductivity measuring value will slowly change, due to unavoidable electrochemical effects (ionic migration, polarisation, surface effects).

² This takes about 30 seconds after the immersion; you can speed-up this by constantly moving the measuring probe.

Finishing the measurement

- 1 *Switch off the MLA 900:* Close the cover flap of the display unit.
- 2 *Remove the measuring probe:* Pull in the measuring probe carefully out of the liquid container (recommendation: wipe the probe cable when pulling out and dry with a soft cloth). Stow the cables and measuring probe in the brackets of the display unit.
- 3 *Stow away the ground clamp:* Detach the ground clamp and attach it to the underside of the display unit.

Measures in the event of a fault/damage

**WARNING: Risks caused by damage**

If a fault or damage to an instrument component is detected, the MLA 900 must not be taken into a hazardous location.

If the MLA 900 is faulty or damaged:

- ▶ Mark the instrument clearly as faulty (for example, using a sticker).
- ▶ Make sure that the MLA 900 is no longer used in hazardous locations.

**WARNING: Risk caused by damaged measuring probe**

If the cylinder of the measuring probe is deformed (for example, partly dented), the conductivity measuring values will be distorted. This fault may not be detected during a performance test (→ S. 21, §4.3).

- ▶ Check the mechanical condition of the measuring probe.

- ▶ *If the MLA 900 is faulty or damaged:* send both the display unit and the measuring probe to the manufacturer's factory for repair (detailed information → S. 13, §3.2).

MLA 900

5 Maintenance

Cleaning
Battery replacement
Spare parts

Bild 7 Surfaces of the measuring probe sensitive to contamination

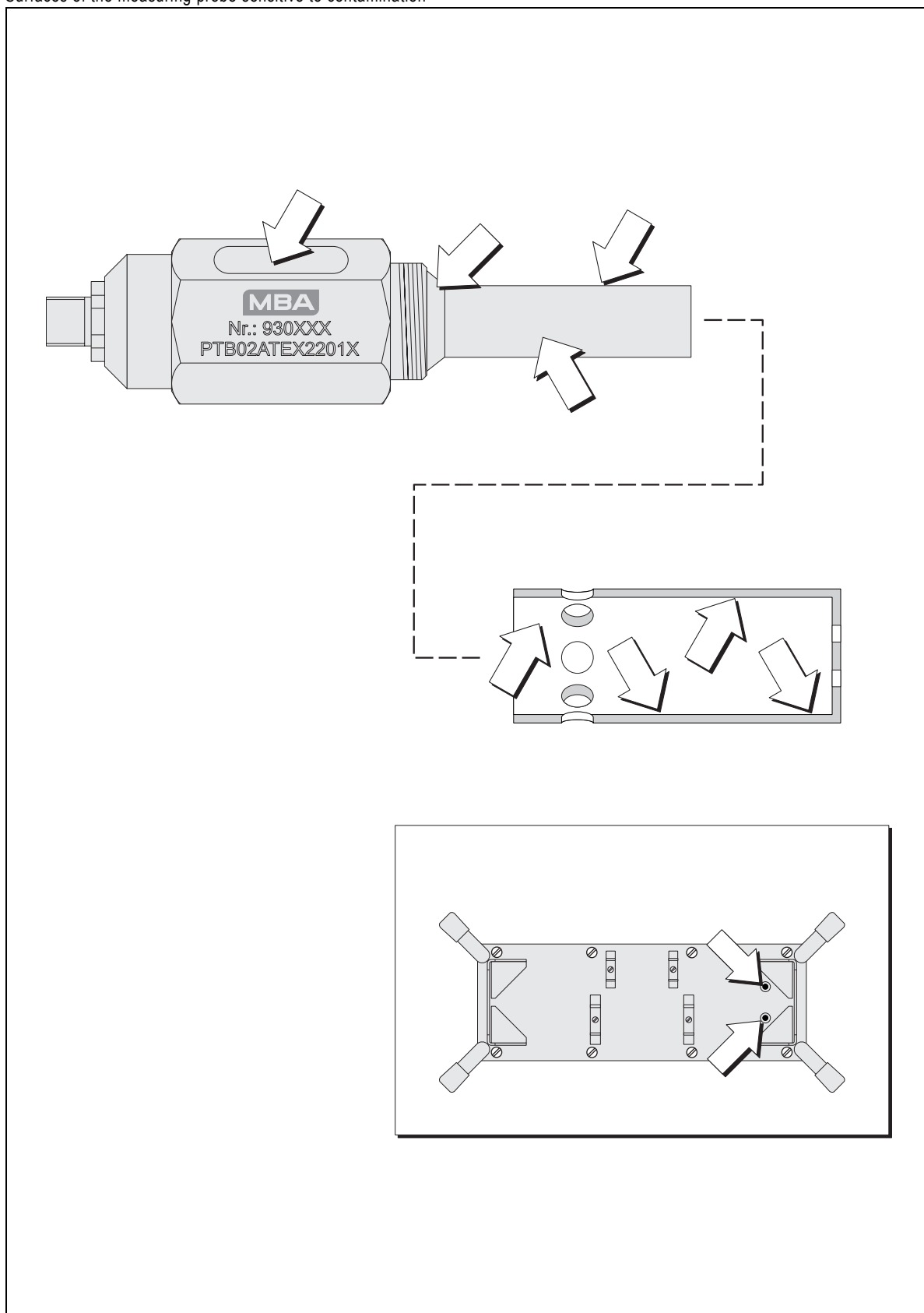

5.1 Cleaning



WARNING: Hazard in explosion-hazardous locations

- ▶ Perform any cleaning works only outside hazardous locations.

5.1.1 Cleaning the probe cable

- ▶ To clean the probe cable, use a soft cloth moistened with spirits or any other mild solvent (→ S. 8, §2.1.2).
- ▶ Make sure that dirt and solvent residue are completely removed.

5.1.2 Cleaning the measuring probe

- 1 Unscrew the cylinder of the measuring probe.



If you are not able to detach the cylinder by hand: try using the two pins on the underside of the display unit which fit into the cylinder face.



CAUTION: Damage risk

- ⊗ Do not fix the measuring probe's body or cylinder in a vice. The pressure from the vice could burst the plastic material in the probe body. Deformations in the cylinder will cause wrong measuring results.

- 2 Clean all surfaces of probe body and cylinder carefully with a soft cloth moistened with a »mild« solvent (→ S. 8, §2.1.2).



The quality of your next measurement depends on how clean the parts of the probe are.



CAUTION: Damage risk

- ▶ Only use solvents which cannot have an aggressive effect on the measuring probe materials (→ S. 8, §2.1.2).
- ▶ Make sure that the plastic material is not scratched. Any dirt collecting in such scratches may affect measuring results.
- ▶ Do not use measuring probes in hazardous locations which have been damaged or attacked by aggressive solvents.

5.1.3 Cleaning the display unit

- ▶ Regularly clean the enclosure of the display unit with a soft cloth moistened with a mild cleaning agent or solvent.
- ▶ Use only solvents which cannot attack the enclosure or the print on the display unit (→ S. 8, §2.1.2).



CAUTION: Risk by damage parts

- ▶ *If the display unit enclosure has been attacked by solvents:* Do not put the MLA 900 into operation.

Figure 8: Changing the battery

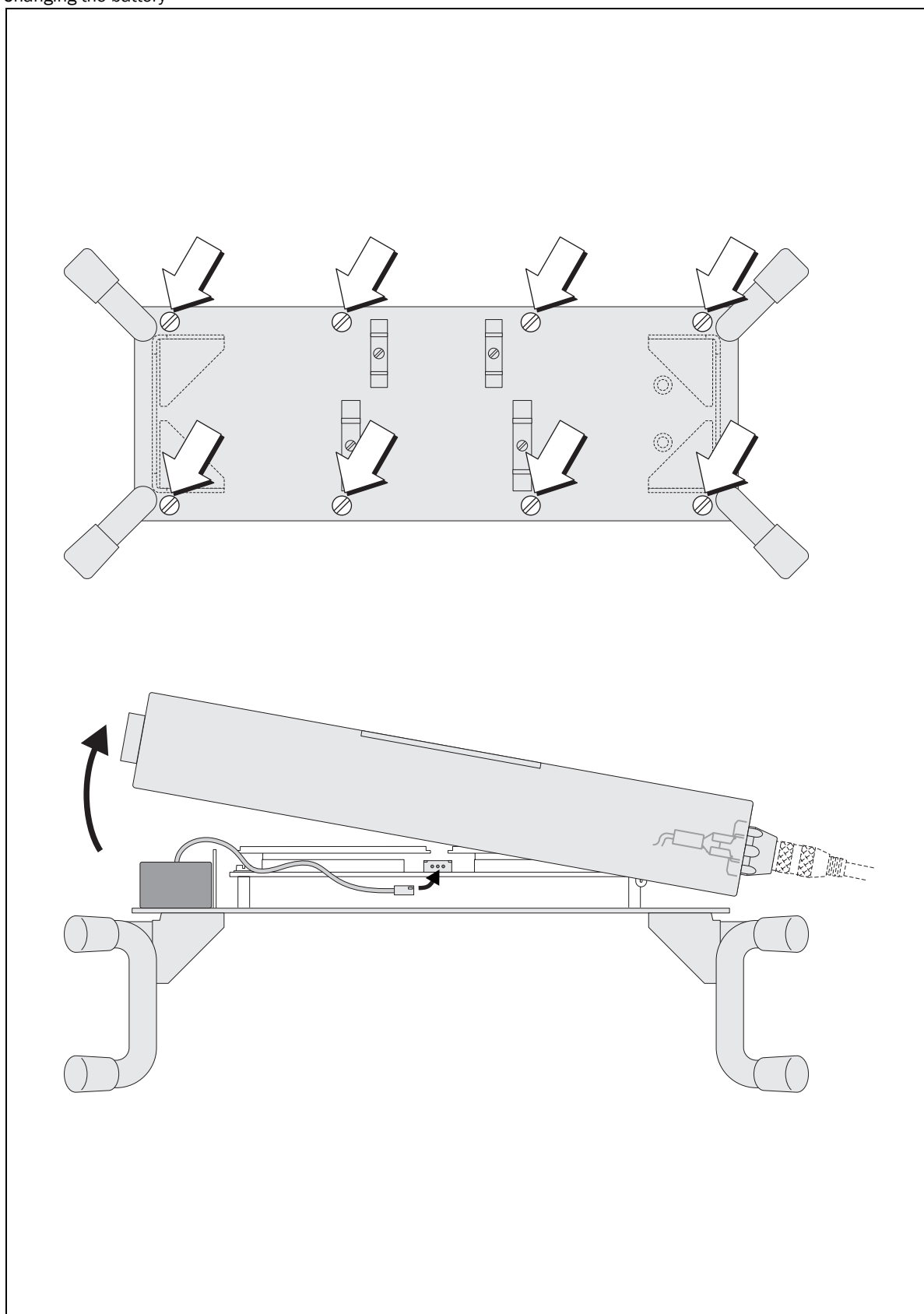

5.2

Battery

Check

When the life of the built-in battery comes to an end, the message *BAT* is indicated on the display.

- ▶ Whenever you open the display unit, check if *BAT* is indicated.

**HINWEIS: Risk of damage by leaking battery**

Caustic liquid could escape from the spent battery and could damage the electronics of the display unit.

- ▶ Remove a spent battery as soon as possible.
- ▶ Replace the built-in battery at the latest after 3 years.
- ▶ Note in a suitable place when the battery was last replaced.

Replacing the battery

**WARNING: Risks in explosion-hazardous locations**

- ▶ When using the MLA 900 in hazardous locations, use only batteries of the original type (→ S. 30, §5.3).
- ⊗ Never open the enclosure inside a hazardous location.

- 1 Undo the 8 screws at the rear of the display unit.
- 2 Lift the upper section of the enclosure on the left-hand side.
→ The battery is located in the lower section.
- 3 Detach the battery cable from the electronics (pin-and-socket connector) and remove the battery.
- 4 Check the enclosure seal.
 - ▶ *If the seal is damaged:* replace the seal (spare parts → S. 30, §5.3).
- 5 Insert the new battery and connect the battery cable.
- 6 Screw the enclosure back together. Make sure
 - that the enclosure seal is correctly positioned
 - that no cables are pinched.
- 7 Carry out a performance test (→ S. 21, §4.3) – *Caution:* for safety reasons, make this first performance test after battery replacement outside hazardous locations.

5.3

Spare parts

Part No.	Description
1025074	MLA900 conductivity measurement device, unit including 02 m cable
1025075	MLA900 conductivity measurement device, unit including 10 m cable
1025076	MLA900 conductivity measurement device, unit including 17 m cable
2028595	Battery
5316999	Permanent magnet for function test
4038445	Transport case
4038461	Carrying belt
6026885	Cable for probe, 2,000mm
6026886	Cable for probe, 10,000mm
6032036	Cable for probe, 17,000mm
4039228	Grounding clamp
5317139	Cable for grounding clamp
5313243	Clamp for grounding clamp SW19,05
5313244	Clamp for probe SW31,75
5316998	Grip holder for enclosure
8011380	User manual MLA900 German
8011381	User Manual MLA900 English
8011430	Calibration
4039227	Seal for housing
2028594	Probe for MLA900 – not available as standalone part due to mandatory calibration test. Please ship measuring instrument (probe) plus MLA900 device with box for factory adjustment test and calibration.



Display unit and measuring probe have been individually adapted in the factory. If you connect a different probe, the measuring accuracy cannot be guaranteed.

- ▶ Only connect the measuring probe to the display unit with the identical serial number on it.



If only the measuring probe or the display unit has become unusable or has been lost, you can send the remaining part to the manufacturer's factory and have this made back into a complete MLA 900.

MLA 900

6 Storage, transport

Storage
Shipping notes

6.1 Correct storage

Please observe these instructions if the MLA 900 is to be taken out of service for more than 3 months:

- ▶ Remove the battery (→ S. 29, §5.2).
- ▶ Keep all the components stored in a dry place at room temperature (15 ... 20 °C/ 59 ... 68 °F).
- ▶ Observe the admissible storage and transport temperature (–20 °C ... +60 °C).



WARNING: Damage risks caused by wrong storage

- At lower temperatures the LC displays in the display unit may freeze, resulting in the enclosure of the LC display bursting.
- Lower temperatures affect the flexibility of the probe cables. At low temperatures avoid bending the probe cables too far as the cable sheath may become brittle and break.
- At higher temperatures there is a risk that caustic fluid may escape from the battery, damaging the electronics. In addition, the LC displays may be damaged (irreversible blackening).

6.2 Short-distance transports

- ▶ Wind-up both the probe cable and the ground cable onto the cable brackets of the display unit.
- ▶ Attach the measuring probe and the ground clamp in the supports on the display unit – do not detach the cable connections.
- ▶ Use the hand-grip to carry the instrument.

6.3 Correct shipping

If the MLA 900 is to be transported over long distances:

- ▶ *Secure instrument:* Wind the probe cable and the cable with the ground clamp carefully onto the cable bracket of the display unit. Attach the measuring probe and the ground clamp in the brackets of the display unit.
- ▶ *Protect the display unit:* Protect the display unit against condensation, humidity and splashing
- ▶ *Packing:* Stow the MLA 900 in transport case supplied.
- ▶ Observe the admissible storage and transport temperature (→ §6.1).
- ▶ *If the instrument is to be sent for repair:* observe the notes in §6.4 (→ S. 33).

6.4

Shipping for repair

- ▶ Always send both the measuring probe and the display unit together for repair (explanation → S. 13, §3.2).



If only the measuring probe or the display unit has become unusable or been lost, you can send the remaining part to the manufacturer's factory and have these made back into a complete MLA 900.

- ▶ Please attach the following notes:
 - A detailed, clear description of the problem (single words are fine, but merely stating that »the instrument does not work« is of little help).
 - A short description of the operating conditions.
 - The name of the our representative who is informed about the problem or with whom you have arranged transport to the workshop.
 - The contact person in your company who can answer any questions that may arise.
- This will help to bring your instrument quickly back to perfect operation. Please add the information even if your matter has already been discussed with our customer service or a representative.

MLA 900

7 Approval certificate

Bild 9

European approval certificate, page 1 of 2

Physikalisch-Technische Bundesanstalt

Braunschweig und Berlin



1. ERGÄNZUNG

gemäß Richtlinie 94/9/EG Anhang III Ziffer 6

zur EG-Baumusterprüfbescheinigung PTB 02 ATEX 2201 X

Gerät: Leitfähigkeitsmessgerät Typ MLA 900
 Kennzeichnung:  II 1/2 G EEx ia IIB T6
 Hersteller: Maihak AG
 Anschrift: 22399 Hamburg, Deutschland

Beschreibung der Ergänzungen und Änderungen

Das Leitfähigkeitsmessgerät Typ MLA 900 mit zugehöriger Sonde dient zur Ermittlung der Leitfähigkeit und der Temperatur von Motoren- und Turbinentreibstoffen zum Beispiel im Einsatzgebiet beim Betanken von Flugzeugen.

Der Firmenname ändert sich und lautet künftig:

MBA Instruments GmbH
 Friedrich-List-Straße 5
 25451 Quickborn

Das Leitfähigkeitsmessgerät Typ MLA 900 besteht aus der Anzeigeeinheit mit der LCD-Anzeige von Temperatur und Leitfähigkeit und Batteriemodul und der Sondeneinheit. Die Sonde ist mit der Anzeigeeinheit über ein Kabel verbunden. Das Leitfähigkeitsmessgerät Typ MLA 900 darf nur mit seinen zugehörigen Komponenten Batteriemodul, Kabel und Sonde betrieben werden.

Das Leitfähigkeitsmessgerät Typ MLA 900 ist in der Zündschutzart Eigensicherheit "I" errichtet und wird von einem internen Batteriemodul versorgt. Die Batterie bildet mit ihren eigensicheren Schutzbauelementen eine Einheit und ist nur als ganzes auswechselbar. Das Auswechseln des Batteriemoduls darf nur außerhalb des explosionsgefährdeten Bereiches bzw. höchstens in Bereichen erfolgen, für die Betriebsmittel der Kategorie 2 erforderlich sind.

Die höchstzulässige Umgebungstemperatur beträgt: +60 °C

ZSEx10101d.dot

Seite 1/2

EG-Baumusterprüfbescheinigungen ohne Unterschrift und ohne Siegel haben keine Gültigkeit.
 Diese EG-Baumusterprüfbescheinigung darf nur unverändert weiterverbreitet werden.
 Auszüge oder Änderungen bedürfen der Genehmigung der Physikalisch-Technischen Bundesanstalt.
 Physikalisch-Technische Bundesanstalt • Bundesallee 100 • 38116 Braunschweig • DEUTSCHLAND

Physikalisch-Technische Bundesanstalt



Braunschweig und Berlin

1. Ergänzung zur EG-Baumusterprüfbescheinigung PTB 02 ATEX 2201 X

Die Normgrundlage für das Leitfähigkeitsmessgerät ändert sich und lautet künftig wie folgt.

Angewandte Normen:

EN 60079-0:2006

EN 60079-11:2007

EN 60079-26:2007

Aufgrund der Änderung der Normgrundlage ändert sich die Kennzeichnung und lautet künftig wie nachstehend.

 II 2(1) G Ex ia IIB T6

Alle bisher getroffenen Festlegungen und Angaben gelten weiterhin unverändert.

Besondere Bedingungen

1. Das Leitfähigkeitsmessgerät Typ MLA 900 darf nur mit seinen zugehörigen Komponenten Anzeigeeinheit mit Batteriemodul, Kabel und Sondeneinheit betrieben werden.
2. Die Anzeigeeinheit des Leitfähigkeitsmessgerätes Typ MLA 900 darf nur in Bereichen betrieben werden, für die mindestens Betriebsmittel der Kategorie 2 erforderlich sind.
3. Die Sonde darf in Bereichen betrieben werden, für die Betriebsmittel der Kategorie 1 erforderlich sind.
4. Das Leitfähigkeitsmessgerät Typ MLA 900 ist ein handgeführtes Messgerät. Das Herablassen der Sonde in Behälter oder Tanks hat gerade und so zu erfolgen, dass mit Schädigungen des Gerätes oder Kabels und Pendeln nicht zu rechnen ist. Die leere innere Tank- bzw. Behälterhöhe vom Messstandpunkt aus darf 24 m nicht übersteigen.
5. Die Anzeigeeinheit des Leitfähigkeitsmessgerätes Typ MLA 900 ist ein tragbares oder aufstellbares Betriebsmittel und so zu errichten und zu bedienen, dass ein Hineinfallen in den Behälter oder Tank auch in seltenen Fällen ausgeschlossen ist.
6. Vor der Inbetriebnahme des Leitfähigkeitsmessgerätes Typ MLA 900 ist dieses mit der hierfür vorgesehenen Klemmvorrichtung zu erden.
7. Die Sonde und das zugehörige Kabel sind vor jedem Einbringen in Behälter oder Tanks auf Beschädigungen hin zu prüfen.

Bewertungs- und Prüfbericht: PTB Ex 10-20082

Zertifizierungssektor Explosionschutz
Im Auftrag

Braunschweig, 22. April 2010

Dr.-Ing. U. Johannsmeyer
Direktor und Professor



Seite 2/2

EG-Baumusterprüfbescheinigungen ohne Unterschrift und ohne Siegel haben keine Gültigkeit.
Diese EG-Baumusterprüfbescheinigung darf nur unverändert weiterverbreitet werden.
Auszüge oder Änderungen bedürfen der Genehmigung der Physikalisch-Technischen Bundesanstalt.
Physikalisch-Technische Bundesanstalt • Bundesallee 100 • 38116 Braunschweig • DEUTSCHLAND

A			
Ambient conditions during operation	8		
Application restrictions	8		
Approval			
- definitions of terms	9		
- European approval	10		
Approved use	8		
Area of application	8		
Assembly	13		
B			
Battery	29		
- replacing	29		
- spare part	30		
C			
Carrying handle	17		
Certificates	35		
Checking the instrument function	21		
Chemical Resistance	8		
Cleaning			
- the display unit	27		
- the measuring probe	27		
- the probe cable	27		
Conductivity display	17		
D			
Damage (consequences)	24		
Definitions of terms	9		
Deformation of the measuring probe	24		
DIN 51412	8 - 9		
Display unit			
- approval	10		
- battery	29		
- cleaning	27		
- connecting the measuring probe	13		
- handling	17		
- performance test	21		
- spare parts	30		
- switching on/off	17		
Displays	17		
- fault	19		
- limit value	19		
E			
EEx ia IIB T6	10		
EIZulBergV	9		
ElexV	9 - 10		
EN (European Standards)	9		
European Standards	9		
F			
Fault (consequences)	24		
Fault displays	19		
G			
Ground terminal			
- handling during measurement	23		
- spare part	30		
- testing	13		
H			
Handling	15		
Hazardous areas	9		
I			
Information symbols	2		
Intrinsically safety	9		
L			
Limit value	19		
M			
Maintenance	25		
Materials (chemical resistance)	8		
Measuring probe			
- approval	10		
- chemical resistance	8		
- cleaning	27		
- connecting the display unit	13		
- handling during measurement	23		
- measures in case of deformation/damage	24		
- performance test	21		
- spare part	30		
Measuring procedure	23		
Measuring value displays	17		
Mining ordinance	9		
O			
Official approval	9		
Operating conditions	10		
P			
Performance test	21		
Preparing for operation	11		
Probe cable			
- cleaning	27		
- connection	13		
- maximum length	13		

R

Regulations 9

S

Seal for display unit 30

Shipping 32

Signal words 2

Spare parts 30

Storage 31 - 32

Supply schedule 12

Switching on/off 17

Symbols (explanation) 2

T

Temperature

- display 17

- during operation 8

- for storage/transport 32

Transport 31 - 32

W

Warning symbols, warning levels 2

Z

Zone 0, Zone 1 9

MLA 900

MBA Instruments GmbH

Friedrich-List-Str. 7 · D-25451 Quickborn · Germany

Telefon +49 (0) 41 06 123 888-0 · Fax +49 (0) 41 06 123 888-9

www.mba-instruments.de · info@mba-instruments.de